

MANUAL

WIRELESS ADDRESSABLE OPTICAL SMOKE DETECTOR SDW-1 «RUBETEK»



Complies with:
EN 54-7
EN 54-25

Hardware version: IP101-02M rev.3
Software version: 2023.05.1 or higher
Document version: 2023-3-1

Table of contents

| | |
|--|----|
| Introduction..... | 3 |
| 1. Description and operation..... | 4 |
| 1.1. Function..... | 4 |
| 1.2. Technical data..... | 4 |
| 1.3. Appearance of the detector..... | 5 |
| 1.4. Internal design of the detector..... | 5 |
| 1.5. Complete set..... | 6 |
| 2. Intended use..... | 7 |
| 2.1. Preparation for use..... | 7 |
| 2.2. Linking the detector to CP..... | 8 |
| 2.3. Detector deactivation..... | 10 |
| 2.4. Bypass mode..... | 11 |
| 2.5. Link quality assessment..... | 12 |
| 2.6. Detector location..... | 13 |
| 2.7. Installation..... | 13 |
| 2.8. Detector SW firmware version check..... | 15 |
| 2.9. Events and reactions configuration..... | 15 |
| 2.10. «Fire 2» alarm configuration..... | 16 |
| 3. Maintenance..... | 17 |
| 3.1. Safety precautions..... | 17 |
| 3.2. Functional test..... | 17 |
| 3.3. Batteries replacement..... | 19 |
| 4. Storage..... | 19 |
| 5. Transportation..... | 20 |
| 6. Disposal..... | 20 |
| 7. Manufacturer's warranty..... | 20 |
| 8. Information about complaints..... | 20 |
| 9. Standards compliance..... | 20 |
| 10. Manufacturer information..... | 21 |

Introduction

This User Manual is intended to describe the operating principle, configuration, installation and operation of the wireless addressable optical smoke detector SDW-1 «RUBETEK» (hereinafter detector).

The detector operates under control of the addressable fire alarm control panel as part of the RUBETEK fire alarm system.

You must read the instructions in the Manual before linking, configuring, operating or maintaining the detector.

Installation and operation of the detector must be carried out by technical personnel after reading this Manual.

List of abbreviations used:

- Base - detector base DB-2 «RUBETEK»;
- CP - addressable fire alarm control panel;
- CW - commissioning works;
- DEVs - alarm and notification devices;
- FA - fire alarm;
- Fire 1 - first alarm state;
- Fire 2 - confirmation alarm signal;
- RE - radio extender module;
- SDW, detector - wireless addressable optical smoke detector SDW-1;
- SW - software.

1. Description and operation

1.1. Function

Wireless addressable optical smoke detector SDW-1 «RUBETEK» is designed for early detection of fires accompanied by smoke in a protected area by measuring the specific absorbance of the medium.

The detector operates as part of the Rubetek automatic fire alarm system, controlled by the addressable fire alarm control panel CP-1 (hereinafter referred to as CP).

Functionality of the detector:

- early detection of fire;
- generation of «Fire» and «Fault» alarms;
- automatic device detection in the system;
- testing of the detector from the CP menu;
- monitoring of the functionality;
- dust control;
- monitoring of the current smoke concentration;
- battery status control;
- anti-temper housing;
- status LED indication;
- setting in the service mode, without interruption of the link and configuration;
- protective cover;
- modern design.

1.2. Technical data

Table 1 - The main parameters of the detector

| Parameter | Value |
|--|---|
| Link interface | RF 868 MHz |
| Number of occupied address slots | 1 |
| Battery voltage, V | – main: 3, battery CR123A 1500 mAh – backup: 3, battery CR2032 210 mAh |
| Battery life* | – main: min 3 years – backup: min 3 months |
| Response level, dB/m | from 0,05 to 0,2 |
| Maximum link range (in open areas), m | 900 |
| Signal encryption | XTEA 128bit |
| Number of channels within frequency range, ea. | 5 |
| Radiation power, mW, max | 25 |
| Tamper sensor | available |
| Operation temperature range, °C | from -10 to + 55 |
| Relative air humidity | up to 93% at +40°C |
| The degree of protection for the housing | IP20 |
| Dimensions, mm | Ø 92 × 42 |
| Weight, g, max | 105 |
| Average lifetime, years | 10 |
| Average time between failures, h | 60000 |

* At an operating temperature above 0°C, taking into account stable radio link, and a polling time of 255 s. Operating time does not take into account batteries discharge during CW.

1.3. Appearance of the detector

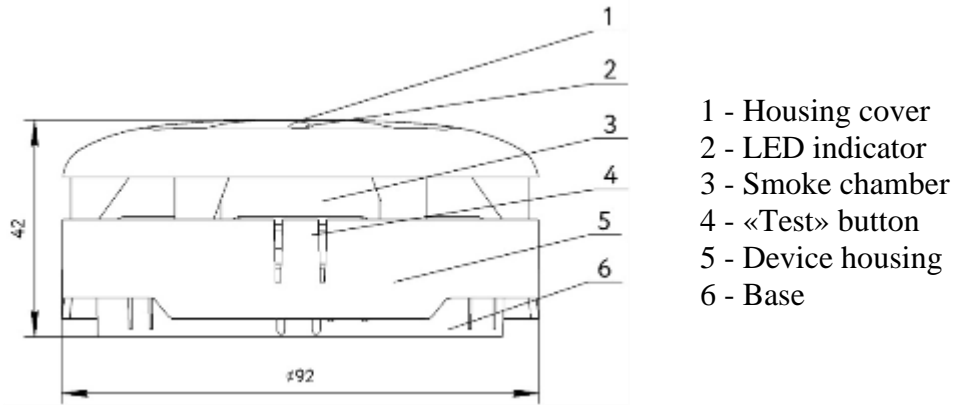

Figure 1 – Appearance of the detector

1.4. Internal design of the detector

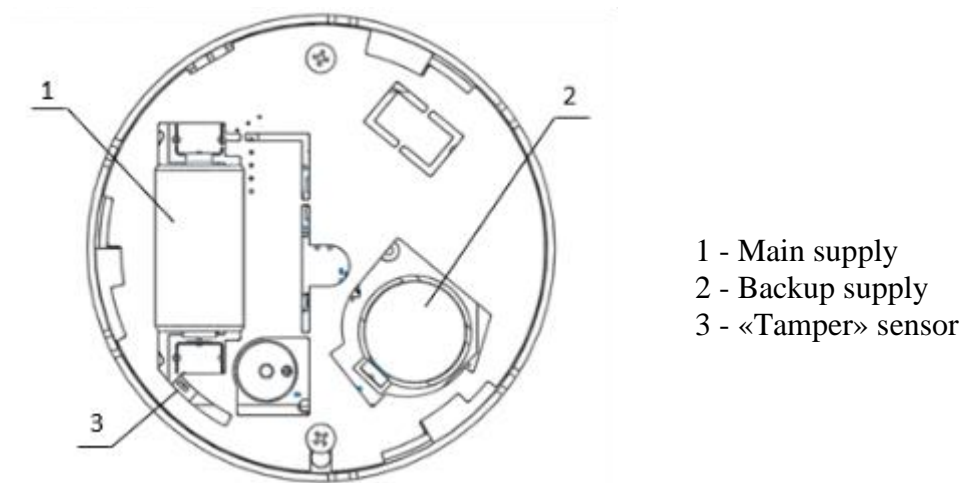

Figure 2 – Internal design of the detector

1.5. Complete set

Table 2 - Complete set of the detector

| Item | Quantity, ea | Remarks |
|---|--------------|-----------------------|
| Wireless addressable optical smoke detector SDW-1 «RUBETEK» | 1 | |
| Detector base DB-2 «RUBETEK» | 1 | Installed on detector |
| Battery CR123A | 1 | Installed on detector |
| Battery CR2032 | 1 | Installed on detector |
| Protective cover | 1 | Installed on detector |
| Mounting kit | 1 | |
| Individual packing | 1 | |
| Passport | 1* | |
| Group packaging | 1* | |

* Per shipping lot.

2. Intended use

2.1. Preparation for use

! ***ATTENTION!** If the detector was in conditions of negative temperature, keep it at least 4 hours at room temperature (25 ± 10 °C) to prevent moisture condensation.*

Open the package, make sure that the completeness of the detector corresponds to table 2.

Conduct an external visual inspection, make sure that there are no visible mechanical damages (chips, cracks, dents) and traces of moisture.

Prepare detector for installation:

Open the housing of the detector. To do this, turn the base of the detector counterclockwise, and with a little effort pull the base of the detector.

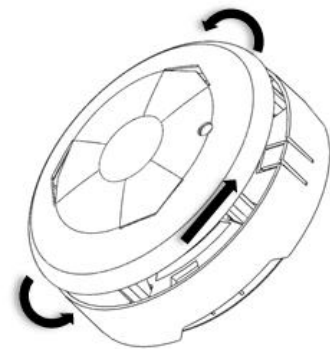

Remove the protective film of the batteries. For this:

- carefully remove the battery;
- remove the protective film;
- observing the polarity indicated on the board, install the battery in place;
- check the tight fit of the contact plates to the battery poles.

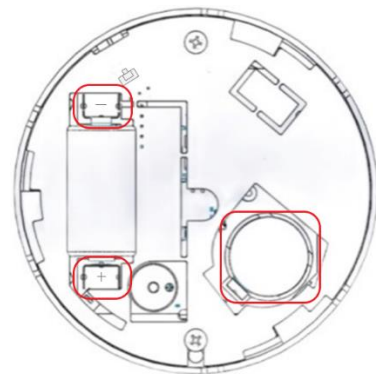

! ***ATTENTION!** Remove first the protective film from the main battery, then remove the protective film from the backup battery.*

The batteries are connected in the following sequence: first install the main battery, then the backup one. After installing the battery wait at least 60 seconds and turn on the pairing mode according to the recommendations of paragraph 2.2 of this Manual. Within 40 seconds from the moment the pairing mode is turned on, the SDW is calibrated.

! ***ATTENTION!** This Manual describes configuration, pairing and link to CP-1.*

2.2. Linking the detector to CP

To link the detector to the CP via radio, ensure the distance between the detector and CP or detector and RE, linked to CP, it must be no more than 10 meters.

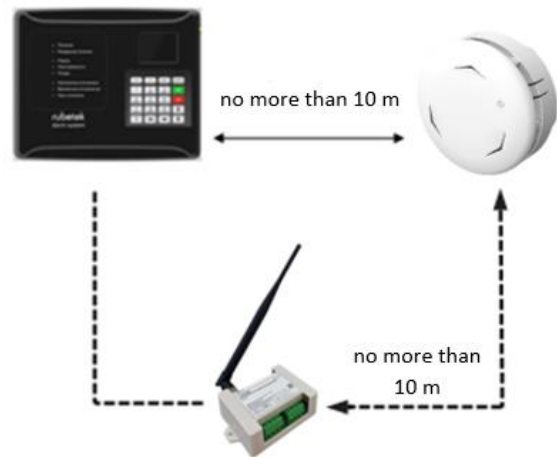

Open the **Fire Alarm Network** menu on the CP screen by pressing the «✓» button on the keyboard. Select item **1.Browse network** and press the **OK** button. Select the required CP. Press the **OK** button.

| | |
|---------------------------|-----------------------|
| Fire Alarm Network | Browse network |
| 1.Browse network | [122] CP-1 |
| 2.Active alarms | 96 faults |
| 3.Alarm causes | |
| 4.Faults | |
| 5.Bypassed DEVs | |

Switch CP to the available devices search mode. To do this:

- in the Main menu of CP select **3.DEVs** and press **OK**.
- select **3.Device pairing** in the submenu. Press **OK**.

| | |
|------------------------|------------------|
| Main menu | DEV |
| 1.Information | 1.Devices list |
| 2.Configuration | 2.Device zones |
| 3.DEVs | 3.Device pairing |
| 4.Events and reactions | 4.Configuration |
| 5.Firefighting | 5.PLC status: |

- select **2.Wireless DEVs** in the submenu. Press **OK**.
- select one item **1.Through CP/SC / 2.Using RE-1** in the submenu. Press **OK**. RF-device pairing menu will open.

| | |
|-----------------------|--------------------------|
| Device pairing | RF-device pairing |
| 1.Wired DEVs | 1.Through CP/SC |
| 2.Wireless DEVs | 2.Using RE-1 (#23) |
| | |

! ATTENTION! Up to 5 detectors can be linked to the CP at the same time. Detectors active for linking within the radio channel coverage area will be displayed in the open list.

| | |
|---|--------------------------|
| Requesting list | RF device pairing |
| Please wait. Pairing list request is processing... | 1: D72C1E / 5s Q:1 |
| | 2: ---empty--- |
| | 3: ---empty--- |
| | 4: ---empty--- |
| | 5: ---empty--- |

Enter the detector into the programming mode, for this it is necessary to hold the **TEST** button on the detector for a long time.



! *ATTENTION! The device will automatically exit pairing mode after 20 seconds.*

The CP will display the serial number and the time since the device was last detected. If the time is more than 5 seconds, then the device is most likely out of pairing mode. Select the right one for pairing detector and press **OK**.

CP will automatically proceed to further configuration of the detector parameters (**DEVS #X** submenu, where X is the number of the slot to which the detector is paired).

Configure the detector:

- **Name** – name of the detector.

! *ATTENTION! To use the created templates at the stage of entering the name for the device, press «0» on the CP keyboard, select a template from the proposed list and press **OK**. 9 templates are available by default: **level, apartment, vestibule, hall, corridor, living room, kitchen, bedroom, bathroom.***

- **Zone** - will allow you to combine devices of one fire zone. There are 32 protected zones on the CP.

! *ATTENTION! For DEVS which do not have a zone set in manual mode, the **Default Zone** configurations will be applied.*

- **Device type*** - determined automatically.
- **Status*** - current state of the detector (norm, housing opening, Fire 1, Fire 2, battery low, link fault).
- **Bypass mode** - detector deactivation/activation in the system.
- **Smoke sensor*** - the value of the current optical density of the smoke chamber.
- **Link*** - parameters of CP link with detector. More details are described in paragraph 2.5 of this Manual.
- **Main supply*** - main battery voltage.
- **Backup supply*** - backup battery voltage.
- **Serial number*** - detector serial number.
- **Firmware version*** - detector firmware version.
- **Device menu** - includes:
 - **Device configuration** - individual device configuration. Described in the paragraph below. If you want to set up a paired detector, wait 20 seconds after switching it to pairing mode. The configuration of this item is available for 30 seconds.
 - **Reaction configuration** - list of alarm signals from the detector, which will be processed by the CP. Reaction configuration is described in detail in paragraph 2.9.1 of this Manual.

| RF device pairing | |
|-------------------|-----------------|
| 1: | D72C1E / 5s Q:1 |
| 2: | ---empty--- |
| 3: | ---empty--- |
| 4: | ---empty--- |
| 5: | ---empty--- |

| DEV #1 | |
|--------------|---------|
| Name: | SDW-1 |
| Zone: | No zone |
| Device type: | |

| DEV #1 | |
|--------------|----------------|
| Status: | Smoke detector |
| | [link fault] |
| Bypass mode: | bypass |

| DEV #1 | |
|---------------|-------------------|
| Smoke sensor: | 0 |
| Link: | T:9999s H:0 Q:0/0 |
| Main supply: | |

| DEV #1 | |
|----------------|--------|
| Backup supply: | 0.0 V |
| | 0.0 V |
| Serial number: | 000001 |

| DEV #1 | |
|-------------------|--------|
| Firmware version: | 000001 |
| | 19.18 |
| Device menu | |
| Delete | |

- **Delete** - device deleting from CP.



ATTENTION! Parameters marked with * are not configurable and are for informational purposes only.

| |
|------------------------|
| #1: rf -type-1 |
| Device configuration |
| Reaction configuration |
| |

In **Device configuration**, the following parameters are available:

- **Status period** – time interval (from 10 to 255s), after which the link of the detector with the CP will be polled. 255s used as a default.



ATTENTION! Reducing the polling time of the detector will shorten battery life.

| |
|----------------------|
| Device configuration |
| Status period: |
| 250 sec |
| Save |

After entering the necessary parameters select **Save** and press **Ok**.

After making all the configurations, press the button **to return to the previous menu**.

The **DEVs** menu will be displayed on CP.

Detector pairing completed.

Close the detector housing. To do this, sink the housing of the detector into the base until it stops, aligning the projections of the housing with the recesses on the base.

Make sure that the detector is in the operating mode. In this case, the LED on the front of the detector will flicker green with an interval of 10 seconds.

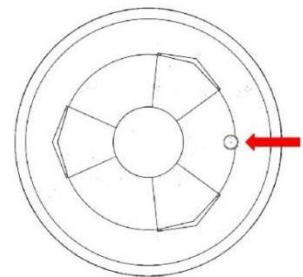

Check the detector pairing to CP. Press **TEST** on detector. The green LED will flash briefly.

A message about testing the device will appear on the CP within 3 seconds, indicating the slot to which it is paired, and the ID (name) of the detector.

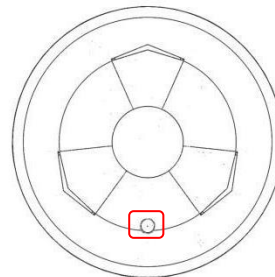

| |
|---------------------|
| Warning ! |
| DEV test! |
| Slot: 43 |
| ID: SDW-1 |
| Zone: No zone |
| 02.02.2023 12:20:36 |

Check if the battery voltage is in accordance with paragraph 3.2.2 of the Manual.

2.3. Detector deactivation

When performing installation and maintenance work, it is recommended to switch the detector to the deactivation mode. At the same time, device pairing to the CP is preserved, but all reactions of the detector become inactive, including the alarm signals «Fire1» and «Fire2» from this detector.

This mode is used to single disable detectors. To disable all RF-devices linked to this CP, use the bypass mode described in paragraph 2.4.

Open the **Fire Alarm Network** menu on the CP screen by pressing the «✓» button on the keyboard. Select item **1.Browse network** and press the **OK** button. Select the required CP. Press the **OK** button.

| Fire Alarm Network |
|--------------------|
| 1.Browse network |
| 2.Active alarms |
| 3.Alarm causes |
| 4.Faults |
| 5.Bypassed DEVs |

| Browse network |
|----------------|
| [122] CP-1 |
| 96 faults |

To deactivate the device, do the following:

- select **3.DEVs** in the main menu. Press **OK**.
- select **1.Devices list** in the submenu. Press **OK**.
- select **2.By number**. Press **OK**.



ATTENTION! Only «occupied» slots are displayed in the devices list. For quick access to a specific slot, press the «0» button on the keyboard and enter the slot number.

- select the right device. Press **OK**.
- select **Bypass mode**. Press **OK**.
- set **bypass**.

| Main menu |
|------------------------|
| 1.Information |
| 2.Configuration |
| 3.DEVs |
| 4.Events and reactions |
| 5.Firefighting |

| DEV |
|------------------|
| 1.Devices list |
| 2.Device zones |
| 3.Device pairing |
| 4.Configuration |
| 5.PLC status: |

| Devices list |
|--------------|
| 1.By zone |
| 2.By number |

| Devices list |
|--------------------|
| 49.rf-type-1 (#49) |
| 50.rf-type-2 (#50) |
| 51.rf-type-3 (#51) |
| 52.rf-type-5 (#52) |
| 53.rf-type-7 (#53) |

| DEV #1 |
|---------------------|
| Status: [norm] |
| Bypass mode: bypass |
| Smoke sensor: |

| Bypass mode: |
|--------------|
| no |
| bypass |

Press **OK** to save.

To activate device, set the value to **no**.

To view the list of deactivated Wireless DEVs on the CP, do the following:

- select **1.Information** in the main menu. Press **OK**.
- select **5.Bypassed DEV list**. Press **OK**.

| Main menu |
|------------------------|
| 1.Information |
| 2.Configuration |
| 3.DEVs |
| 4.Events and reactions |
| 5.Firefighting |

| Information |
|---------------------|
| 1.Active alarms |
| 2.Active signals |
| 3.Faults |
| 4.Fire sources |
| 5.Bypassed DEV list |

After that you can see the list of wireless DEVs which are deactivated on the system with their slot number #X.

| Bypassed devices list |
|------------------------------|
| 1."rf-type-7" (No group) #49 |

2.4. Bypass mode

Bypass mode is used to simultaneously disable all RF-devices linked to a given CP. At the same time, pairing and the devices configurations are preserved. Reactions of disconnected devices are not displayed on the CP and do not trigger events. Alarm signals «Fire1» and «Fire2» from detectors are transmitted, but are inactive on the CP.

! *ATTENTION! On the CP home screen, a quick bypass transfer of «in-fire» devices is available by entering a pin code. PIN code is set by the administrator.*

To configure the «sensor bypass» mode on the CP during the CW stage, do the following:

- In DEV **Main menu** select **7.Mode** and press **Ok**.
- In the list that opens, select the mode: **sensors bypass** - this mode allows the CP to ignore alarms from detectors. Press **Ok**.

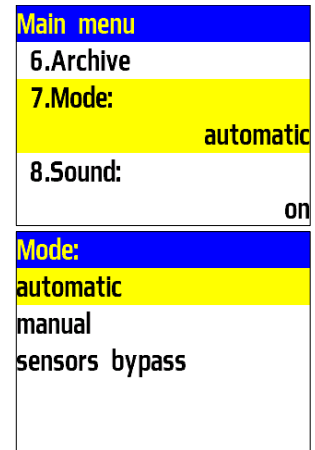

! *ATTENTION! In this mode, the «Automation off» indicator flashes, and the «Sensor off» indicator glows yellow.*

To return to automatic mode, select **7.Mode** in the CP main menu, press **Ok**, select **Automatic** in the submenu.

! *ATTENTION! We recommend using this mode when conducting CW, in order to avoid excessive battery discharge until the equipment is handed over to the operating company.*

2.5. Link quality assessment

To view device link parameters, do the following:

- select **3.DEVs** in the main menu. Press **Ok**.
- select **1.Devices list** submenu. Press **Ok**.
- select **2.By number**.

Press **Ok**.

- select the right device. Press **Ok**.
- select **Link**: it displays the parameters of the link between the CP and the device;

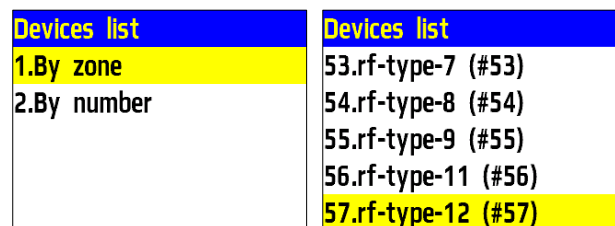
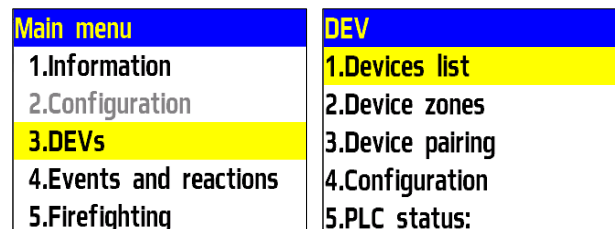

- **T**: time since the last contact;
- **H**: symbol of the device linked (0-to CP, 1-15 to RE);
- **Q**: link quality level (CP-detector / detector-CP or RE). The signal level can vary from -109 to +15 dB.

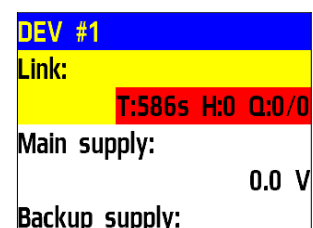

The link signal quality graph is shown in figure 3.

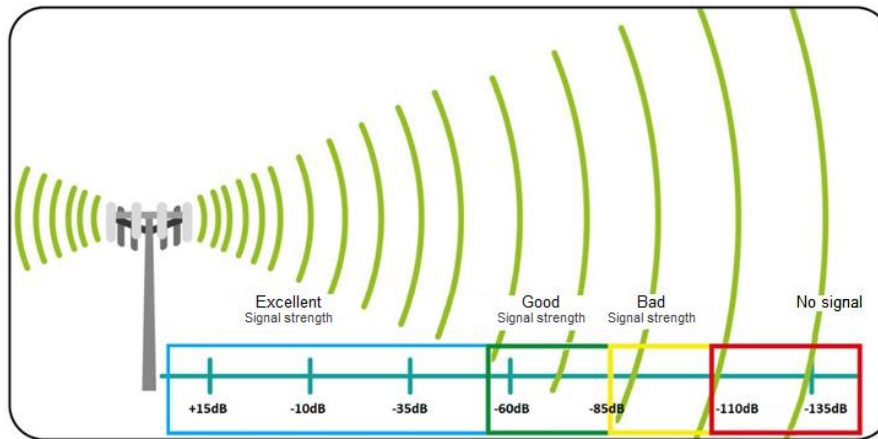

Figure 3 – The link signal quality graph

The recommended link quality in the detector intended installation location should be above -80 dB. If the signal level is lower, use one of the solutions:

- reduce the distance between the detector and CP;
- locate RE between detector and CP;
- install the remote antenna on CP;
- locate the detector according to the cl.2.6 of this Manual.

2.6. Detector location

! *ATTENTION! Location and installation of the detector should only be carried out after it has been linked to the CP.*

! *ATTENTION! The CP receives a signal from the detectors installed within its range. The maximum link range in open areas is up to 900 meters. Please note that obstacles between the detector and the CP may interfere or block the signal.*

For a more stable signal, it is recommended to keep the distance from vertical surfaces at least 0.5 m, from beams, elevator shafts, cable vertical channels at least 0.7 m.

Do not install a detector:

- outdoors, in places where there is a possibility of water getting on the detector housing;
- in a room with a high content of dust, suspensions of building materials in the air, vapors and aerosols that cause corrosion;
- in places with high air currents (for example, near fans, radiators and ventilation ducts);
- near high-frequency communications, power cables, routes.

! *ATTENTION! Before installing detectors, it is strongly recommended to assess the quality of link for each detector in accordance with paragraph 2.5 of this Manual!*

2.7. Installation

! *ATTENTION! Install the detector only after making sure that the device works correctly in the selected installation location! How to locate the device is described in paragraph 2.6 Detector location.*

Attach the device base to the selected installation location and mark the mounting holes with a pencil

Drill holes and fix the base with two screws and two dowels from the mounting kit.

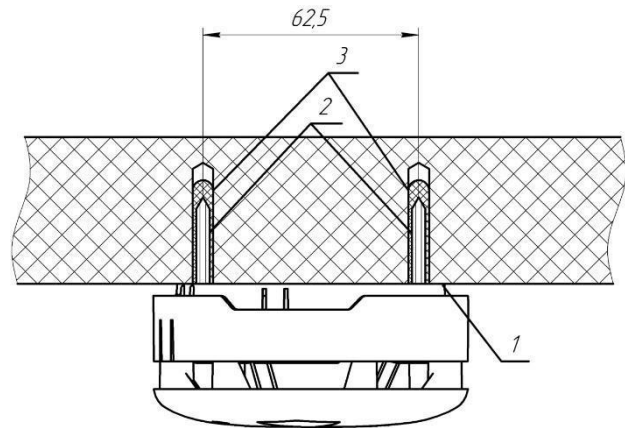

- 1 - Base
- 2 - Screw
- 3 - Dowel

Install the detector on the base. Drown housing into the base until it stops, aligning the projections of the housing with the recesses on the base.

Rotate the detector clockwise.

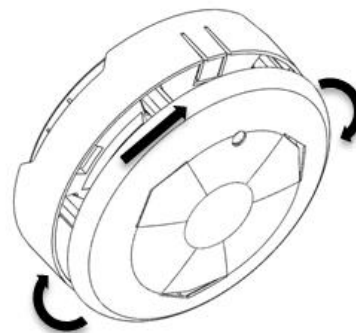

Having completed installation of the detector, check for 255 s that the following alarm signals are not generated: «Fire», «Fault». The LED indication of the detector must correspond to the standby mode in accordance with Table 3.

Table 3 - LED indication of the detector

| Status of the detector | Green indicator | Red indicator |
|------------------------|------------------|--------------------------|
| Standby mode | Every 10 s | |
| Alarm mode | | Every 3 s |
| Main battery low | | Every 10 s |
| Backup battery low | | Every 10 s, double flash |
| «PROG» mode | Frequent flashes | |
| Link by tamper | Single flash | |
| Link by test | | |

Test the detector by pressing the **TEST** button. Make sure the message about testing the installed detector appear on the CP display within 3 seconds.



ATTENTION! During and after installation, a protective cap must be installed on the detector to prevent dusting of the chamber and false alarms of the system. The protective cap is removed from the detectors after the system is commissioned to the operating company.



ATTENTION! During CW, in order to avoid excessive batteries discharge, it is recommended that you switch the CP to «Bypass mode» until the equipment is handed over to the operating company.

After installation of the entire FA system, its performance is checked according to the technical documentation for the CP.

2.8. Detector SW firmware version check

To check the device SW firmware version, do the following:

- select **3.DEVs** in the main menu. Press **OK**.
- select **1.Devices list** submenu. Press **OK**.
- select **2.By number**. Press **OK**.
- select the right device. Press **OK**.
- select **Firmware version**.

Check the current SW version against the latest one.

| | |
|--------------------------|---------------------|
| Main menu | DEV |
| 1.Information | 1.Devices list |
| 2.Configuration | 2.Device zones |
| 3.DEVs | 3.Device pairing |
| 4.Events and reactions | 4.Configuration |
| 5.Firefighting | 5.PLC status: |
| Devices list | Devices list |
| 1.By zone | 51.rf-type-3 (#51) |
| 2.By number | 52.rf-type-5 (#52) |
| | 53.rf-type-7 (#53) |
| | 54.rf-type-8 (#54) |
| | 55.rf-type-9 (#55) |
| DEV #1 | |
| | 000001 |
| Firmware version: | 19.18 |
| Device menu | |
| Delete | |

2.9. Events and reactions configuration

A complete list of events and reactions configuration in the fire alarm «RUBETEK» is given in the operation manual for the CP.

Events configuration must be carried out only by qualified personnel, taking into account the requirements of the working and design documentation for fire alarms and automation per facility.

Prior to events configuration read this User Manual and CP User Manual.



ATTENTION! 128 events can be configured per CP in the system. Events are configured in accordance with the working documentation for the facility.

2.9.1. Detector reactions

Reaction is processed on the CP when device status parameters are received.

Open the **Fire Alarm Network** menu on the **CP** screen by pressing the «✓» button on the keyboard. Select item **1.Browse network** and press the **OK** button. Select the required **CP**. Press the **OK** button.

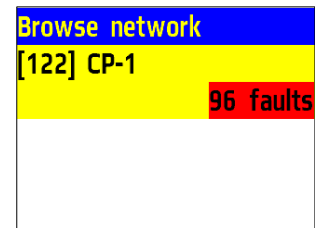
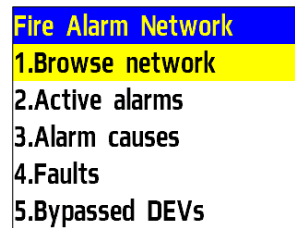

To activate device reactions, do the following:

- select **3.DEVs** in the main menu. Press **OK**.
- select **1.Devices list** submenu. Press **OK**.
- select **2.By number**. Press **OK**.
- select the right device. Press **OK**.
- select **Device menu**. Press **OK**.
- select **Reaction configuration**. Press **OK**.
- select **Reactions**. Press **OK**.

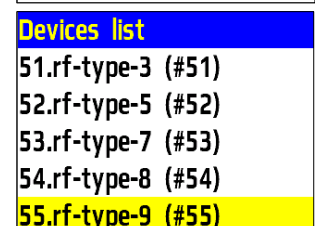
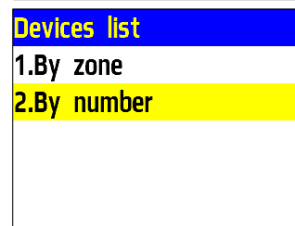
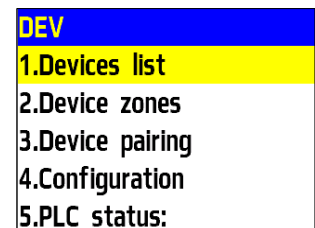
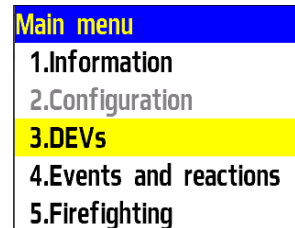

To activate menu items, use arrows ← → on the CP keyboard. Press **OK** to save changes.

The list of required reactions is given below.

The list of required reactions:

- **Fire2 from DEV**. - delivery of a message to the CP when the chamber is filled with smoke with saving it in the archive.
- **Tamper** - delivery of a message to the CP when the casing is opened with saving it in the archive.

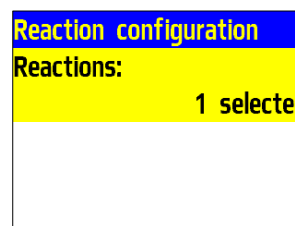
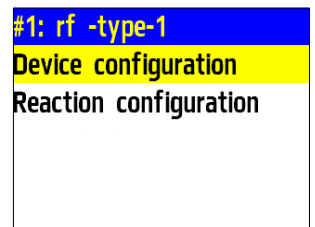
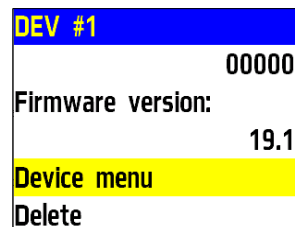

- **Test button** - delivery of a message to the CP when pressing the «Test» button with saving it in the archive.
- **Main low**. - delivery of a message to the CP when the main battery is low with saving it in the archive.
- **Backup low**. - delivery of a message to the CP when the backup battery is low with saving it in the archive.

2.10. «Fire 2» alarm configuration

The CP is configured for the «Fire 2» alarm signal from one of the detectors by default. The following algorithm is implemented: when the camera of one of the detector smokes, the «Fire 1» alarm signal is sent to the CP, after 60 seconds, if the status of this detector is unchanged or repeated, the «Fire 2» alarm signal is triggered on the CP, the fire alarm and the configured events are triggered.



ATTENTION! With this configuration, if two or more devices of the same zone are triggered with an interval of no more than 60 seconds, the «Fire 2» alarm signal will automatically start on the CP.

For configuration of triggering the «Fire 2» alarm signal only from two or more detectors of the same zone, do the following:

- select **3.DEVs** in the main menu. Press **Ok**.
- select **2.Device zones**. Press **Ok**.
- select the right **Zone**. Press **Ok**.
- select **Fire 2 by single det.** Press **Ok**.
- set time **0000**. Press **Ok**.
- make sure that for **Fire 2 by two and more: on** is selected.

| Main menu |
|------------------------|
| 1.Information |
| 2.Configuration |
| 3.DEVs |
| 4.Events and reactions |
| 5.Firefighting |

| DEV |
|-----------------------|
| 1.Devices list |
| 2.Device zones |
| 3.Device pairing |
| 4.Configuration |
| 5.PLC status: |

| Zones configuration |
|---------------------|
| Default zone |
| Zone 1 |
| Zone 2 |
| Zone 3 |
| Zone 4 |

| Zone configuration |
|-------------------------------|
| Zone 1 |
| Fire 2 by single det.: |
| 0000 sec |
| Fire 2 by two and more: |
| on |

| Fire 2 by single det.: |
|------------------------|
| 0060 |

3. Maintenance

3.1. Safety precautions

- 3.1.1. During the repair work in the room where the detector is installed, protection against mechanical damage and ingress of building materials (whitewash, paint, dust, etc.) must be provided.

3.2. Functional test

- 3.2.1. Detector functional test should be carried out during scheduled or other functional checks of the detector, but at least once every 6 months.
- 3.2.2. Functional test includes:
 - detectors status test for CP:

For device status test do the following:

- select **3.DEVs** in the main menu. Press **Ok**.
 - select **1.Devices list** submenu. Press **Ok**.
 - select **2.By number**. Press **Ok**.
 - select the right device. Press **Ok**.
- Select the detector from the list and press **Ok**.

| Main menu |
|------------------------|
| 1.Information |
| 2.Configuration |
| 3.DEVs |
| 4.Events and reactions |
| 5.Firefighting |

| DEV |
|-----------------------|
| 1.Devices list |
| 2.Device zones |
| 3.Device pairing |
| 4.Configuration |
| 5.PLC status: |

| Devices list |
|--------------------|
| 1.By zone |
| 2.By number |
| |

| Devices list |
|---------------------------|
| 50.rf-type-2 (#50) |
| 51.rf-type-3 (#51) |
| 52.rf-type-5 (#52) |
| 53.rf-type-7 (#53) |
| 54.rf-type-8 (#54) |

In the menu **DEVs** that opens select **Status**. If the detector has faults or events, they will be displayed.

| DEV #46 |
|--------------------------------|
| No zone |
| Device type: Smoke detector |
| Status: |
| link fault |

 **ATTENTION!** *If link with the detector is lost, faults received before the loss of link will be displayed.*

- link quality check. Performed in accordance with paragraph 2.5 of this Manual;
- checking the reaction of the detector to opening the case:
 - remove the detector from the base by turning the housing counterclockwise,
 - pull with a little force applied on the housing of the detector,
 - open the detector, a message about opening the housing should appear on the CP,
 - close the housing. Install the detector on the base, pushing until it clicks. Turn the detector clockwise until it stops.
- checking the battery voltage of the main and backup battery:

To check the battery voltage of the device, do the following:

- select **3.DEVs** in the main menu. Press **Ok**.
- select **1.Devices list** submenu. Press **Ok**.
- select **2.By number**. Press **Ok**.
- select the right device. Press **Ok**.

| Main menu |
|------------------------|
| 1.Information |
| 2.Configuration |
| 3.DEVs |
| 4.Events and reactions |
| 5.Firefighting |

| DEV |
|-----------------------|
| 1.Devices list |
| 2.Device zones |
| 3.Device pairing |
| 4.Configuration |
| 5.PLC status: |

| Devices list |
|--------------------|
| 1.By zone |
| 2.By number |
| |

| Devices list |
|----------------------------|
| 53.rf-type-7 (#53) |
| 54.rf-type-8 (#54) |
| 55.rf-type-9 (#55) |
| 56.rf-type-11 (#56) |
| 57.rf-type-12 (#57) |

In the menu **DEVs** that opens, select **Main supply** or **Backup supply**. With voltage less than 2.2V, batteries must be replaced according to the paragraph 3.3 of this User Manual.

| DEV #1 | |
|-----------------------|-------|
| Main supply: | 0.0 V |
| Backup supply: | 0.0 V |
| Serial number: | |



ATTENTION! If the voltage is less than 2.2V, the CP receives a «Main supply low» fault message indicating the name of the device and the slot to which it is paired. In this case, the device automatically switches to the backup battery. The fault will be cleared only after battery with voltage over 2.8V replacement.

ATTENTION! If the value of 0.0V is displayed in the battery voltage field, this indicates a possible:



- no battery;
- polarity reversal of the battery when installed in the device;
- no contact on the contact plates;
- installing a faulty battery.

In this case dismantle the device and inspect it to eliminate possible causes of the battery failure.

- external inspection of the detector for traces of moisture and mechanical damage;
- checking the indication of the detector: «Standby mode» according to table 3;
- external examination of the smoke chamber of the detector for dust. If there is dust on the smoke chamber, replace the detector deleting the current detector from the CP and adding a new one according to paragraph 2.2, or blow the smoke chamber with a pneumatic cleaner with compressed air.

3.3. Batteries replacement



ATTENTION! When replacing batteries, observe the polarity indicated on the board! If one battery fails, both batteries are replaced.

- Prepare new main and backup batteries;
- Remove the detector from the mount. To do this, turn the detector counterclockwise;
- Remove the old battery and install a new one, observing the polarity;



ATTENTION! First, the main battery is replaced, then the backup one.

- Check for contact between contact plates and battery poles;
- Assess the link quality in accordance with paragraph 2.5 and check the battery voltage in accordance with paragraph 3.2.2;



ATTENTION! Information on the CP about the battery voltage, after its replacement, is updated within 100 seconds, so wait at least this period of time before checking the data on the CP.

- Install the detector on the base, aligning the mounting holes on the detector with the fixing projections of the bracket.

4. Storage

- 4.1. Store the detector on racks in a packaged form.
- 4.2. The distance from the walls and floor of the storage to the detector packages must be at least 0.1 m.

- 4.3. The distance between the heaters and the detector packages must be at least 0.5 m.
- 4.4. The room must be free of vapors of aggressive substances and conductive dust.

5. Transportation

- 5.1. The packaged detector can be transported by all means of transport in covered vehicles and in pressurized aircraft compartments.
- 5.2. The conditions of transportation must comply with the following conditions:
 - ambient air temperature from minus 50 °C to plus 50 °C;
 - relative air humidity up to 95% at a temperature of plus 40 °C.
- 5.3. The period of transportation and intermediate storage should not exceed 3 months. It is allowed to increase the period of transportation and intermediate storage of the detector during transportation due to the storability time in stationary conditions.

6. Disposal

- 6.1. Batteries are disposed by handing over used batteries to an organization that accepts used batteries. The detector does not contain other toxic components.
- 6.2. The detector is disposed when there are no toxic components in it.
- 6.3. The content of precious materials does not require record during storage, issue, disposal.

7. Manufacturer's warranty

- 7.1. The manufacturer guarantees the compliance of the detector with the technical specifications, provided that the consumer observes the rules of transportation, storage, installation and operation.
- 7.2. Warranty period of operation is 12 months from the date of commissioning, but not more than 24 months from the date of manufacture.
- 7.3. During the warranty period, the replacement of failed detectors is carried out by the manufacturer free of charge, provided that the consumer observes the instructions for installation and operation.
- 7.4. When sending the detector for repair, it must be accompanied by an act describing the malfunctions of the detector.
- 7.5. The warranty does not take effect in the following cases:
 - non-compliance with this User Manual;
 - mechanical damage of the detector;
 - repair of the detector by a person other than Manufacturer.
- 7.6. The warranty applies only to the detector. All third-party equipment used in conjunction with the detector is covered by their own warranties.

8. Information about complaints

- 8.1. Warranty claims are made to the supplier in case the defects and malfunctions are detected which lead to the failure of the detector within the warranty period.
- 8.2. In the certificate of defect indicate: device type, defects and malfunctions, conditions under which they were detected, time since the start of operation of the detector.
- 8.3. A copy of the payment document for the detector must be attached to the act.

9. Standards compliance

- 9.1. Wireless addressable optical smoke detector SDW-1 «RUBETEK» complies with the European standard EN 54-7 «Fire detection and fire alarm systems. Part 7: Smoke detectors - Point

detectors using scattered light, transmitted light or ionization» and EN 54-25 «Fire detection and fire alarm systems. Part 25: Components using radio links».

10. Manufacturer information

- 10.1. Name of the manufacturer's organization: DEVICE FACTORY L.L.C
- 10.2. Legal address: 302020, Ippodromny In 9/24, Orel, Russian Federation
- 10.3. Phone: +7 (4862) 51-10-91
- 10.4. Email: info@zavodpriborov.com

