



# VIDEO INTERCOM DOOR PANEL

**RV-3434**

Technical Data Sheet

## Description

Video Intercom Door Panel RV-3434 is designed to prevent unauthorized access to buildings and areas and provide audiovisual communication for users with their visitors. It supports both indoor and outdoor installation, which makes it suitable for a wide variety of applications. Thanks to its continuous operation, the device is capable of providing non-stop surveillance and access control for residential complexes, buildings or office spaces.

## Key Features



Wide-angle Full HD camera



External card reader support



Facial recognition access

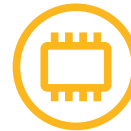

Color LCD display



Easy system setup



Remote configuration

## Mobile app

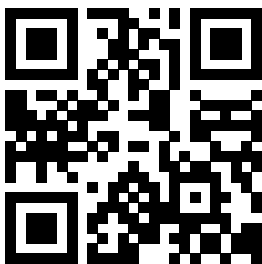

The mobile app allows you to manage the device from any place in the world. You may switch on devices and monitor their operation even when you're hundreds of miles away from home.



# Dimensions

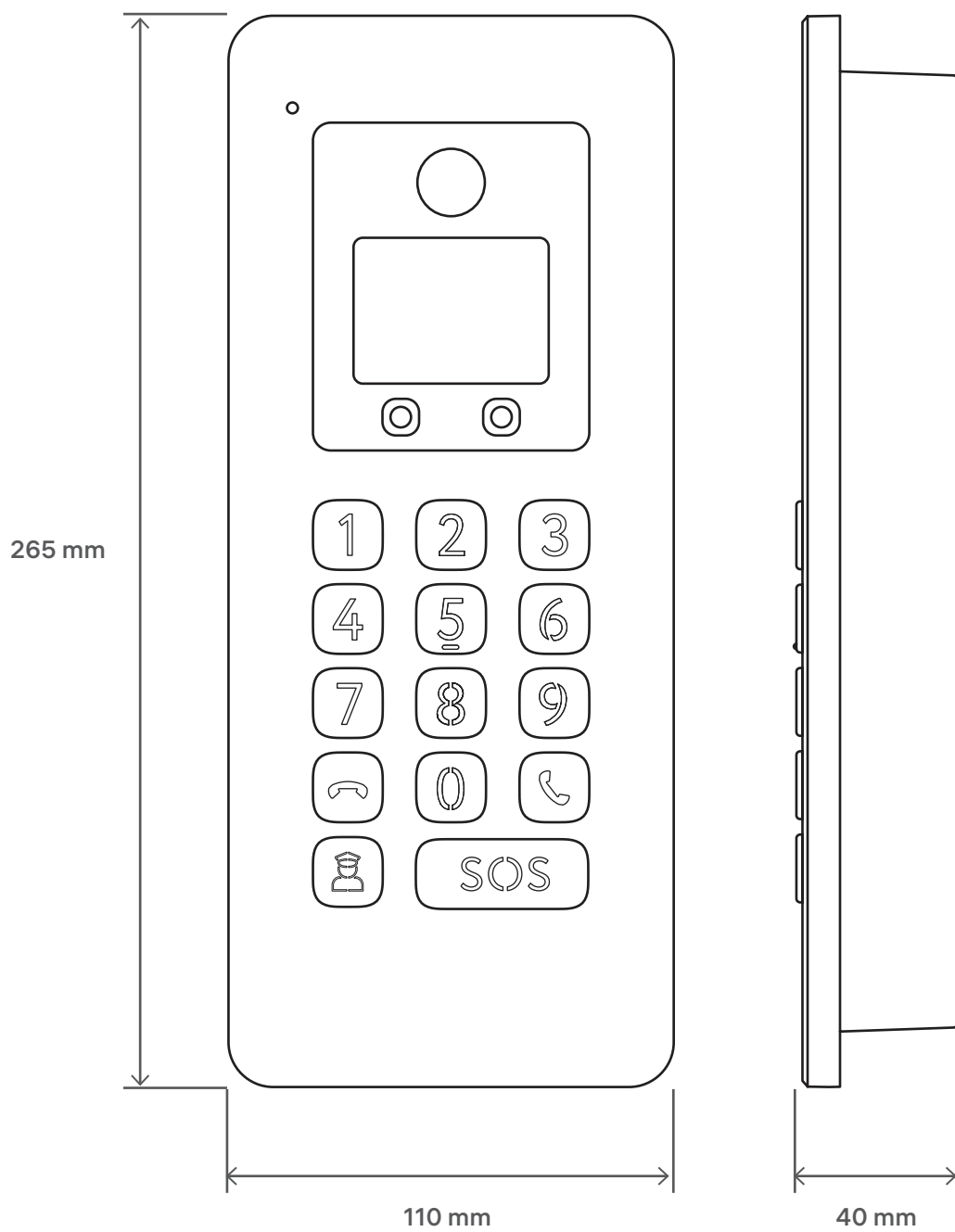

# Basic Layout

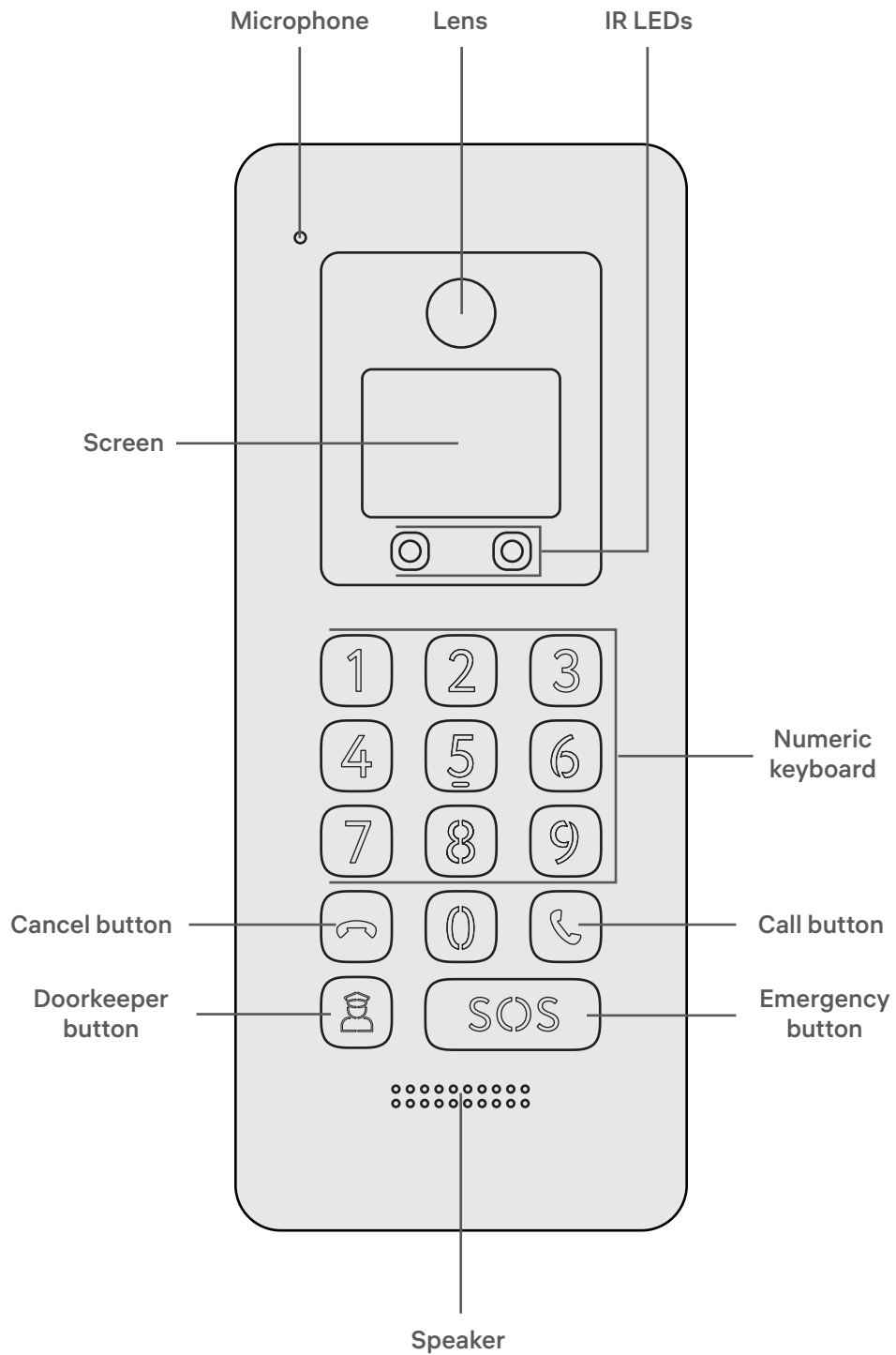

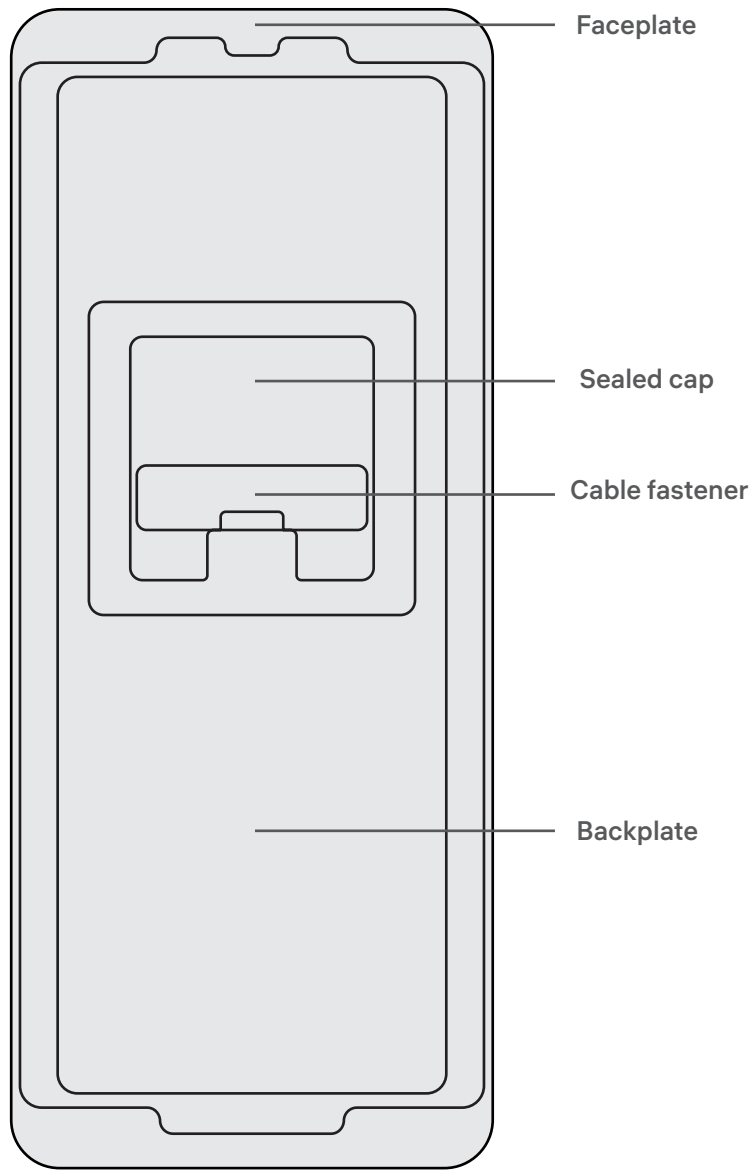
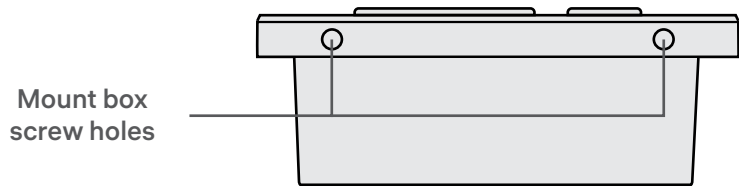

Connection terminals  
(under the cap)

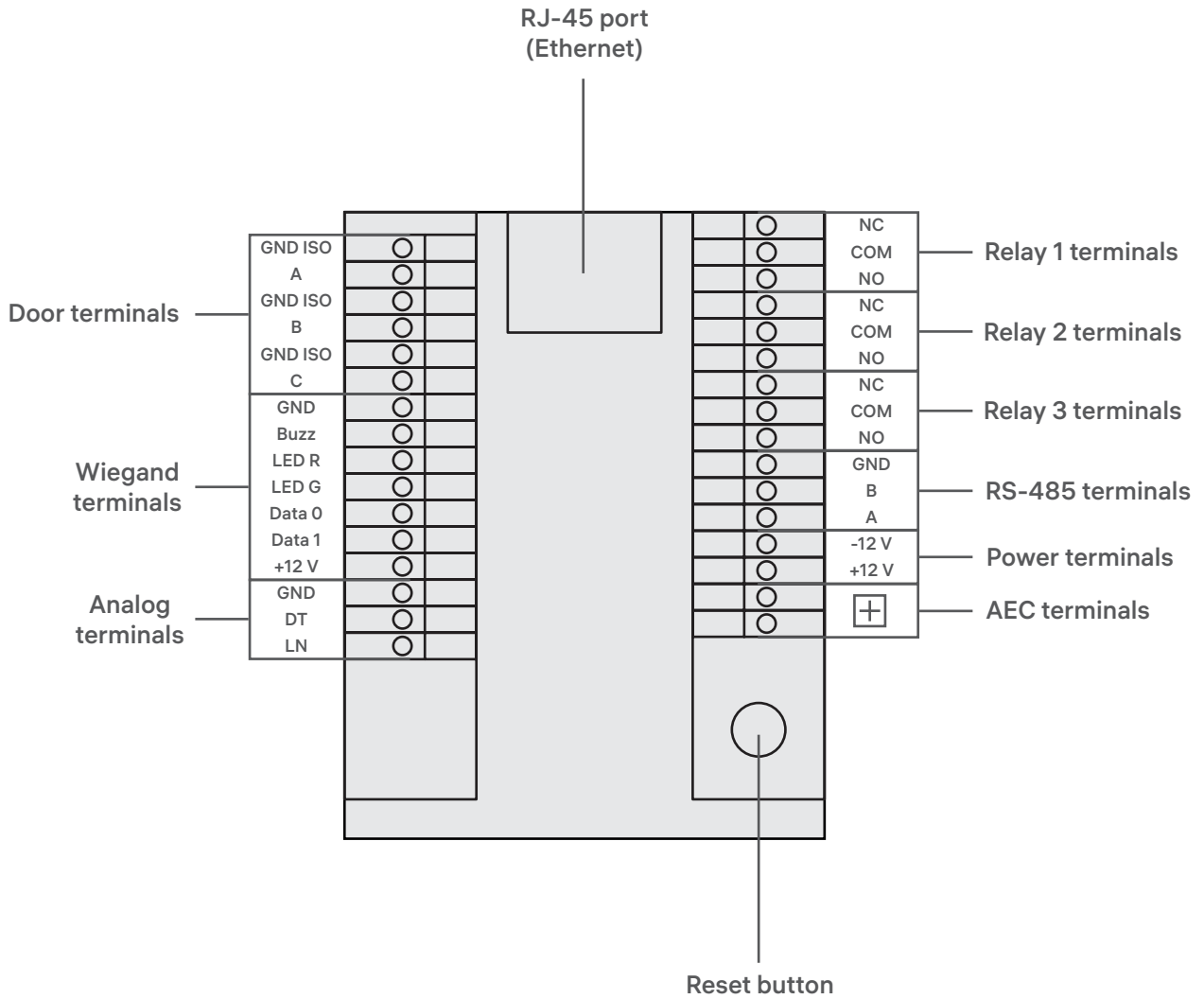

# Specifications

## General Parameters

|                               |  |
|-------------------------------|--|
| Power supply                  | DC: 12 V, POE: IEEE 802.3af  |
| Power consumption             | max. 13 W  |
| Reverse polarity protection   | yes  |
| Surge protection              | yes  |
| Device interfaces             | Ethernet (RJ-45) — 1<br>Wiegand — 1<br>RS-485 — 1<br>Dry contact NO NC — 3<br>Digital inputs — 3<br>NFC — 1<br>Analogue output — 1 |
| Internal card reader          | NFC cards RFID reader with Mifare Plus SL3 support   |
| External card readers support | yes, Wiegand — 26, 32, 34, 40, 42, 56, 58, 64  |

## Keypad

|                |   |
|----------------|---|
| Keys           | Numeric — 10<br>Call — 1<br>Cancel — 1<br>Doorkeeper — 1<br>Emergency — 1 |
| Keypad type    | mechanical  |
| Keys backlight | yes, with adjustable brightness   |

## Camera

|                                 |   |
|---------------------------------|---|
| Primary video stream resolution | 1920×1080 (Full HD)   |
| FOV(H/V)                        | 110°/70°  |
| Sensor size                     | 1/2.8"  |
| Resolution                      | 4 MP  |
| Max. frame rate                 | 30 fps  |
| Video bitrate                   | CBR/VBR/CVBR/AVBR/FixQP/QVBR from 512 kbit/s to 8192 kbit/s |
| Protocol                        | RTSP  |
| Day/Night mode                  | yes   |
| Motion detection                | yes   |

## Display

|                    |         |
|--------------------|---------|
| Type               | TFT LCD |
| Display resolution | 320×240 |
| Display size       | 2.4"    |
| Backlight          | yes     |

## Additional

|                              |   |
|------------------------------|---|
| Light sensor                 | yes   |
| Tamper detection             | yes   |
| Access keys number supported | 10 000  |
| SIP accounts number          | 2   |
| SIP accounts supported       | SIP (RFC 3261), SIP v2 (RFC 3515)   |
| Network protocols            | IPv4, HTTP, HTTPS, FTP, DNS, NTP, RTSP, RTP, TCP, UDP, ICMP, DHCP, ARP, SIP |
| Remote configuration         | yes   |
| Remote firmware update       | yes   |

## Operation

|                         |   |
|-------------------------|---|
| Mounting method         | surface and flush mounting  |
| Operating temperature   | -45°C...+55°C   |
| Operating humidity      | 10%...90%   |
| Protection rating       | IP66, IK08  |
| Electrostatic discharge | 90 kV, 3 W  |
| Dimensions              | 265×110×40 mm (device only)<br>265×110×46 mm (including surface mount box)<br>265×110×50 mm (including flush mount box)<br>270×128×106 mm (including angle mount box in 30° position)<br>270×140×122 mm (including angle mount box in 55° position) |
| Weight                  | max. 0.8 kg (device only)   |



## Available Colors



Gray



Black

## Package Contents

|                                   |       |
|-----------------------------------|-------|
| Video Intercom Door Panel RV-3434 | 1 pc  |
| Cap seal                          | 1 pc  |
| Cap                               | 1 pc  |
| Cable seal                        | 3 pcs |
| Cable fastener                    | 1 pc  |
| Mounting screws kit               | 1 pc  |
| Mounting kit                      | 1 pc  |
| Technical certificate             | 1 pc  |
| Warranty card                     | 1 pc  |

## Available Accessories



Surface mount box  
RV-3434/S

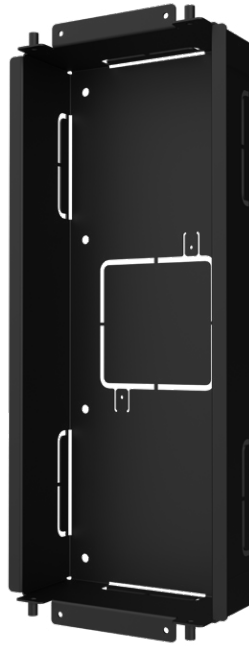

Flush mount box  
RV-3434/F



Angle mount box  
RV-3434/A

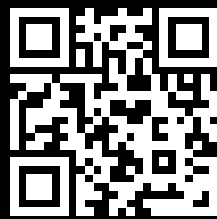

[rubetek.com](https://rubetek.com)